

# SAFETY MODULES AD SR SERIES INSTALLATION USE AND MAINTENANCE

## INDEX

INTRODUCTION.....	3
AD SR1 MODULE.....	4
OPERATING MODES DESCRIPTION .....	4
AUTOMATIC.....	4
MANUAL.....	5
CONNECTION OF EXTERNAL CONTACTORS K1 and K2.....	5
SIGNAL DESCRIPTION.....	6
The RESTART command.....	6
K1K2 FEEDBACK input.....	7
SYSTEM STATUS output.....	7
INSTALLATION AND ELECTRICAL CONNECTIONS.....	7
Characteristics of the output circuit.....	7
Use of K1 and K2 auxiliary contact elements.....	8
Warnings regarding the connection cables.....	8
STATUS INDICATORS .....	9
DIMENSIONS .....	9
TECHNICAL DATA .....	10
STATUS INDICATORS / FAULT DIAGNOSIS.....	11
Status indicators.....	11
FAULT DIAGNOSIS .....	12
MODULE AD SRM.....	13
OPERATING MODES DESCRIPTION .....	13
AUTOMATIC.....	13
MANUAL.....	14
CONNECTION OF K1 K2 EXTERNAL CONTACTORS.....	15
CONNECTON EXAMPLES .....	16
CONNECTION OF AD SRM WITH AN ADMIRAL BARRIER (MANUAL MODE, WORKING RANGE=18m, K1K2 EXTERNAL CONTACTORS, TIMEOUT MUTING=30s).....	16
MUTING FUNCTION.....	16
Muting sequence.....	17
MUTING OVERRIDE FUNCTION.....	18
Override with mantained action control .....	19
Override with pulse control .....	19
STATUS INDICATORS .....	20
INSTALLATION AND ELECTRICAL CONNECTIONS.....	20
Characteristics of the output circuit.....	21
Use of K1 and K2 auxiliary contact elements.....	21
Warnings regarding the connection cables.....	21
SIGNALS DESCRIPTION.....	22
The RESTART command.....	23
K1K2 FEEDBACK input.....	23
SYSTEM STATUS output.....	23

---

DIMENSIONS .....	23
TECHNICAL DATA .....	24
STATUS INDICATORS / FAULT DIAGNOSIS .....	25
Status indicators (BASE MODULE) .....	25
Status indicators (MUTING MODULE) .....	25
Fault diagnosis .....	25
Status indicators (MUTING MODULE) .....	26
GUARANTEE .....	27

 This symbol indicates an important personal safety warning. Failure to comply with the warning may result in very high risk for exposed personnel.

## INTRODUCTION

The AD SR1/AD SRM interface, connected to an IEC 61496 - 1/2 certified type 4 safety light curtain and equipped with two auto-controlled PNP type solid-state outputs, is a type 4 ESPE (Electro-sensitive Protective Equipment).

The other characteristics indicated above remaining constant, if the light curtain is type 2, the entire ESPE will be type 2.

### The AD SR1 main features are the following:

- Inputs for the connection of one safety barrier with fail safe outputs
- Restart manual or automatic selectable
- 2 N.O. outputs with guided contact safety relays
- 1 system monitor PNP output
- 1 external contactors feedback input

### The AD SRM main features are the following:

- Inputs for the connection of one safety barrier with fail safe outputs
- Restart manual or automatic selectable
- 2 N.O. outputs with guided contact safety relays
- 1 system monitor PNP output
- 1 external contactors feedback input
- Muting function with two sensors logic
- 1 Muting function enable input
- 1 muting lamp output
- Muting Override function integrated
- Selectable muting timeout

The safety modules also guarantees that:

- the output lines are open if the barrier is intercepted;
- the output lines are enabled only with correct response times;
- in manual mode, maintenance of the RESTART contact closed is not interpreted as AUTO mode.

 For safe use of the device, it is essential to read and understand the contents of this handbook.

 Failure to comply with the prescriptions indicated in this handbook may result in very high risks for the operating personnel of the machine protected.

# AD SR1 MODULE

## OPERATING MODES DESCRIPTION

OPERATING MODES SELECTION		
TERMINAL 5	TERMINAL 6	OPERATION
0 Vdc	+24 Vdc	<i>Automatic</i>
+24 Vdc	0 Vdc	<i>Manual</i>
0 Vdc	0 Vdc	<i>Non-permissible conditions</i>
+24 Vdc	+24 Vdc	

**Table 1**

### AUTOMATIC

In this operating mode, the outputs of the safety module follow the status of the photocell:

- with the protected area free (outputs of the barrier active), the relay outputs of the control unit are active.
- with the protected area occupied (outputs of the barrier de-activated), the relay outputs of the safety module are de-activated.

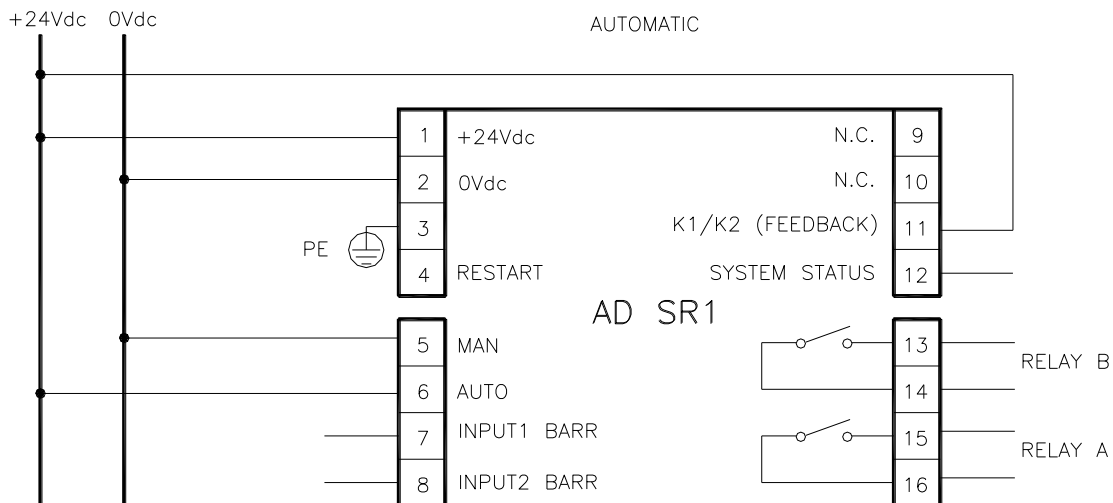

**Figure 1**

- ⚠ Use in manual mode (start/restart interlock activated) is mandatory in the case in which the safety device controls an access protecting a danger zone and once a person has passed through the opening, he/she may remain in the danger zone without being detected (use as trip device according to IEC 61496). Failure to comply with this rule may result in very serious risks for the persons exposed.
- ⚠ Check correct functioning of the entire safety system (control unit+barrier) following each re-installation. In particular, if the original operating mode was Manual, check that the unit has been reconfigured in this mode.

## MANUAL

In this operating mode, the outputs of the control unit are activated only if the protected area is free and after sending the RESTART signal to the control unit using the push-button or by means of a specific command on the RESTART input (terminal 4).

Once the protected area has been occupied, the relay outputs are deactivated. The sequence described above must be repeated in order to re-activate them.

The RESTART command is active with a voltage of 24 Vdc.

The minimum duration of the command is 100 ms.

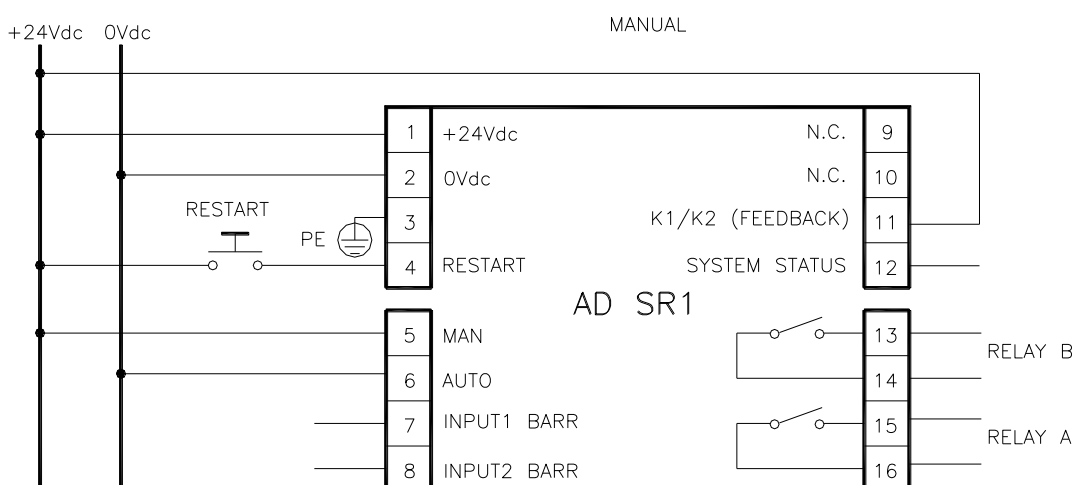

**Figure 2**

## CONNECTION OF EXTERNAL CONTACTORS K1 and K2

Control of external contactors K1K2 can be activated in both operating modes. If this control must be used, the series of normally closed contacts of the external contactors must be connected to terminal 11 of the control unit (figures 3 and 4).

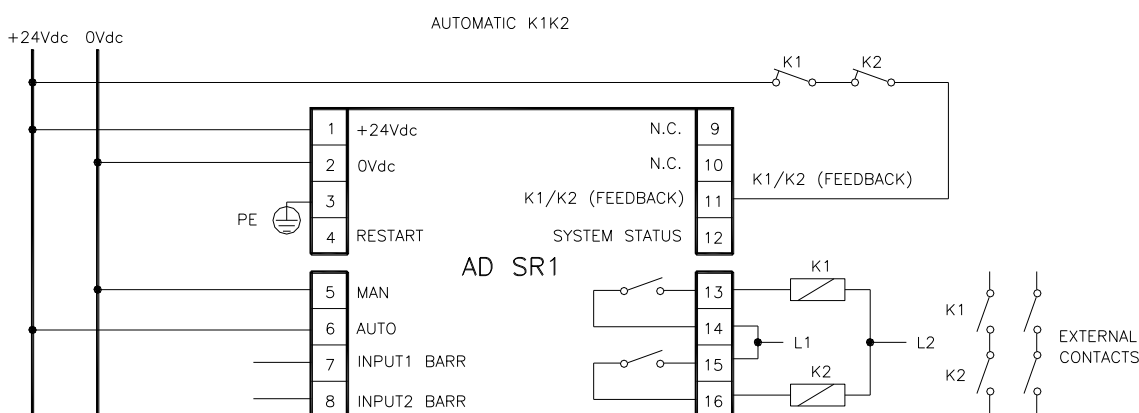

**Figure 3**

**Automatic functioning with K1K2 relays**

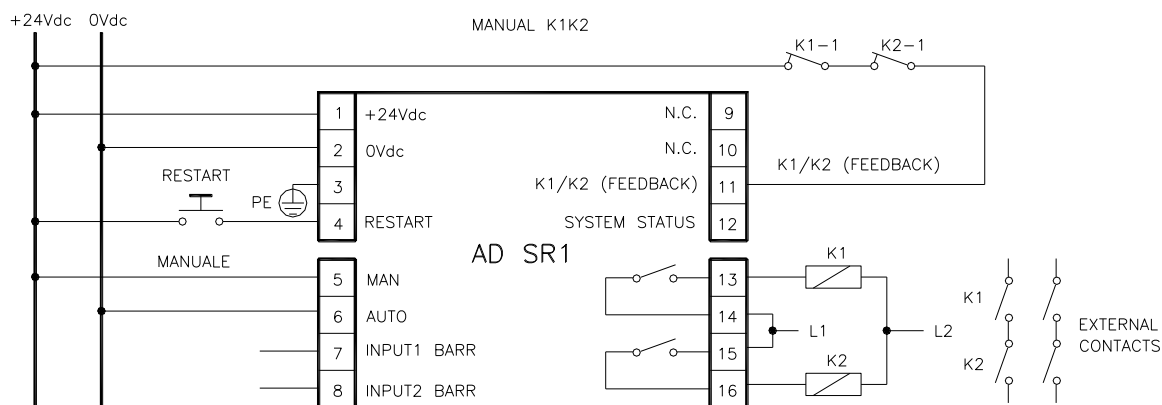

**Figure 4**  
Manual operation with K1/K2 relays



## SIGNAL DESCRIPTION

TERMINAL NUMBER	SIGNAL NAME	TYPE OF SIGNAL	DESCRIPTION
1	24VDC		Power supply 24Vdc
2	0VDC		Power supply 0Vdc
3	PE		Ground connection
4	RESTART	Input	Restart command
5	MAN	Input	Manual/Automatic Configuration
6	AUTO	Input	
7	INPUT1 BARR	Input	Safety barrier input 1 status
8	INPUT2 BARR	Input	Safety barrier input 2 status
9	n.c.	-	-
10	n.c.	-	-
11	K1K2 (Feedback)	Input	Feedback external contactors K1K2
12	SYSTEM STATUS	Output	Output status
13	Relay B NO1	Output	Safety relay B, contact 1 (N.O.)
14	Relay B NO2	Output	Safety relay B, contact 2 (N.O.)
15	Relay A NO1	Output	Safety relay A, contact 1 (N.O.)
16	Relay A NO2	Output	Safety relay A, contact 2 (N.O.)

**Table 2**

### The RESTART command

- The RESTART command must be sent to the control unit connecting terminal 4 to the +24Vdc.
- The contact used for the RESTART command must be able to switch a voltage of 24Vdc and a current of 20mA (guaranteeing a closing time > 100ms). This data is particularly important in the case of automatic management of the RESTART command sending, for example using a PLC.
- The SYSTEM RESET TIME is obtained adding the reset time of any external contactors K1K2 to the reset time of the AD SR control unit (100ms).
- In the case of manual activation, a normally open external button can be used, temporary closing of which generates the RESTART command.

-  The Restart command must be installed outside the danger area in a position where the danger area and the entire work area concerned are clearly visible.
-  It must not be possible to reach the control from inside the danger area.

### ***K1K2 FEEDBACK input***

Using the K1 and K2 auxiliary safety contactors with guided contact safety type, it is necessary to connect the +24Vdc to the **K1K2 FEEDBACK** through the series of the K1-1 e K2-1 N.C. control contacts. The control of the correct switching of K1 and K2 is performed with a delay of 300ms after the real command.





When the K1-1 e K2-1 N.C. control contacts are not used (or no control is provided) it is mandatory to connect the terminal 11 (**K1K2 FEEDBACK**) to the +24Vdc.

### ***SYSTEM STATUS output***

The SYSTEM STATUS output reports exactly the output safety relays status :

- When the output relays are opened, the SYSTEM STATUS reports 0VDC.
- When the output relays are closed, the SYSTEM STATUS reports +24VDC.

## INSTALLATION AND ELECTRICAL CONNECTIONS

-  Install the AD SR1 control unit in an environment with a protection rating of at least IP54.
-  If more modules AD SR1 must be installed in the same board panel, in order to avoid overheating, maintain between them one minimal distance of 2cm.
-  The AD SR1 control unit must be supplied with a 24Vdc  $\pm 20$ .
-  The external power supply must comply with the standard EN 60204-1.
-  During the installation of the AD SR1 control unit be sure to avoid short circuits between the contacts 7 and 8.

### ***Characteristics of the output circuit.***

For the output circuit, the control unit uses two guided contact safety relays.

These relays are rated by the manufacturer for voltage and current values above those indicated in the technical data; however, to assure correct insulation and to avoid damage or premature aging, protect each output line with a 4A slow-blow fuse and check that load characteristics comply with the indications given in the table below.

Minimum switching voltage	18 Vic
Minimum switching current	20 am
Maximum switching voltage	250Vac
Maximum switching current	2A

---

**Use of K1 and K2 auxiliary contact elements.**

---

For loads with higher voltage and current characteristics than those indicated in the table above, use of auxiliary external relays or contactors suitable for the load to be controlled is recommended.

- The K1 and K2 auxiliary contactors or relays must be of the guided contact safety type.
- Referring to the table below, pay particular attention to the configuration of the control contacts on terminal 11 and that of the contacts of use.

	<b>Relay K1</b>	<b>Relay K2</b>
Control contacts	K1-1 normally closed	K2-1 normally closed
Use contacts	K1-2 normally open	K2-2 normally open

- Control contacts K1-1 and K2-1 (terminal 11) must be able to switch a current of 20mA and a voltage of 24Vdc.
- To increase the electrical life of internal relays A and B, it is advisable to use anti-disturbance devices which must be connected across the coils of K1 and K2.

---

**Warnings regarding the connection cables.**

---

- For light curtain/control unit connections of more than 50m, cables with a cross-section of at least 1mm<sup>2</sup> must be used.
- It is good practice to separate the power supply of the control unit from that of other electrical appliances (electrical motors, inverters, frequency variators) or other sources of disturbance.
- The path of the connection cables between the control unit and the sensors, the connection referring to the test command and feedback contacts connected to terminal 11 must be different from that of other power cables.



## STATUS INDICATORS

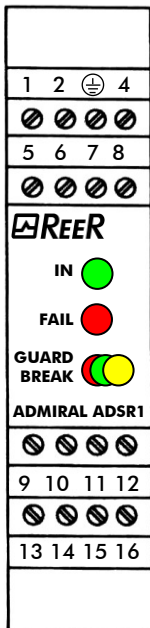

LED	COLOR	STATUS	CONDITION
IN	Green	ON	Barrier free
		OFF	Barrier intercepted
FAIL	Red	ON	Fault detected *
		OFF	Correct operation
GUARD BREAK	Green/ Red/ Yellow	RED	Output relays opened
		RED blinking	The number of blinkings shows the kind of FAIL (only with FAIL is ON) *
		GREEN	Output relays closed
		YELLOW	Barrier free - Output relays opened (only in manual mode)

**Table 3**

\* REFER TO THE "FAULT DIAGNOSIS" SECTION TO HAVE A DETAILED EXPLANATION OF THE POSSIBLE FAULT

## DIMENSIONS

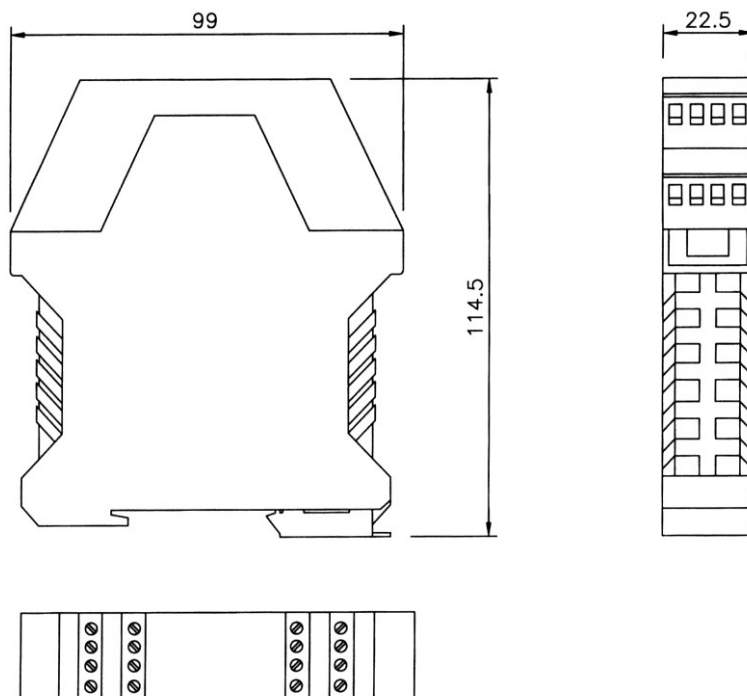

**Figure 5**

**TECHNICAL DATA AD SR1**

Safety category		4
Power supply	Vdc	24 ± 20%
Power requirement	W	5 max
Output	Relay	2 N.O. contacts (2A; 250V)
System Status Output		100mA; 24Vdc
Response time	ms	20 max
Operating modes		Manual or Automatic, selectable from terminal block
External relay control		2 N.C. contacts (20mA; 24Vdc)
Number of connectable barriers		1 (with 2 PNP safety static outputs)
Connections		Terminal block with protection against reversal of polarity
Status indicators	Led	Power On - Barrier status - Fail
Max. length of connections	m	100
Operating temperature	°C	0 ÷ 55
Enclosure protection rating		IP 20
Terminal block protection rating		IP 2X
Fastening		Fast attachment to rail according to EN 50022-35
Dimensions (h x w x d)	mm	99 x 22,5 x 114,5
Weight	g	150
B10d		800.000
Device lifetime		20 years
Safety level	Type 4	IEC 61496-1:2004 IEC 61496-2:2006
	SILCL 3	IEC 62061:2005
	Cat.4	ISO 13849-1 : 2006

Load	Number of Commutations	PFHd *	DCavg #	MTTFd #	PL #	CCF #
2A@230Vac	1 every 30s	2,64E-08	98,92%	26,06	d	80%
	1 every min	1,55E-08	98,85%	50,29	e	80%
	1 every hour	4,93E-09	97,24%	100,00	e	80%
	1 every day	4,77E-09	96,89%	100,00	e	80%
0,5A@24Vdc	1 every 30s	4,86E-08	98,96%	13,28	d	80%
	1 every min	2,64E-08	98,92%	26,06	d	80%
	1 every hour	5,11E-09	97,51%	100,00	e	80%
	1 every day	4,78E-09	96,91%	100,00	e	80%

**Table 4**

\* IEC 62061

# ISO 13849-1







## STATUS INDICATORS / FAULT DIAGNOSIS

### Status indicators

LED			MEANING
IN GREEN	FAIL RED	GUARD/BREAK RED/GREEN	
ON	ON	Red	Power on TEST
OFF	OFF	Red	Barrier INTERCEPTED, outputs in OFF
ON	OFF	Yellow	Barrier FREE, outputs in OFF (module waiting for RESTART)
ON	OFF	Green	Barrier FREE, outputs in ON

**Table 5**

**FAULT DIAGNOSIS**

		LED		MEANING
IN GREEN	FAIL RED	GUARD/BREAK RED/GREEN (pulses led Red)		
OFF	ON		(2 pulses)	Internal fault
OFF	ON		(3 pulses)	Internal relays fault
OFF	ON		(4 pulses)	K1K2 external relays fault
OFF	ON		(5 pulses)	User configuration failure
OFF	ON		(6 pulses)	User configuration changed without system restart: Switch off and restart the module to solve the problem. At the switch on verify the new user configuration.
OFF	ON		(7 pulses)	Possible overload or SYSTEM STATUS connection error

**Table 6**

 If it is not possible to clearly identify the malfunction and to remedy it, stop the machine and contact the ReeR's Assistance Service.



**⚠** Check correct functioning of the entire safety system (module+barrier) following each re-installation. In particular, if the original operating mode was Manual, check that the unit has been reconfigured in this mode.

**MANUAL**

In this operating mode, the outputs of the control unit are activated only if the protected area is free and after sending the RESTART signal to the control unit using the push-button or by means of a specific command on the RESTART input (terminal 15).

Once the protected area has been occupied, the relay outputs are deactivated. The sequence described above must be repeated in order to re-activate these.

The RESTART command is active with with a 0VDC ---> +24Vdc transition.

The minimum duration of the command is 100 ms.

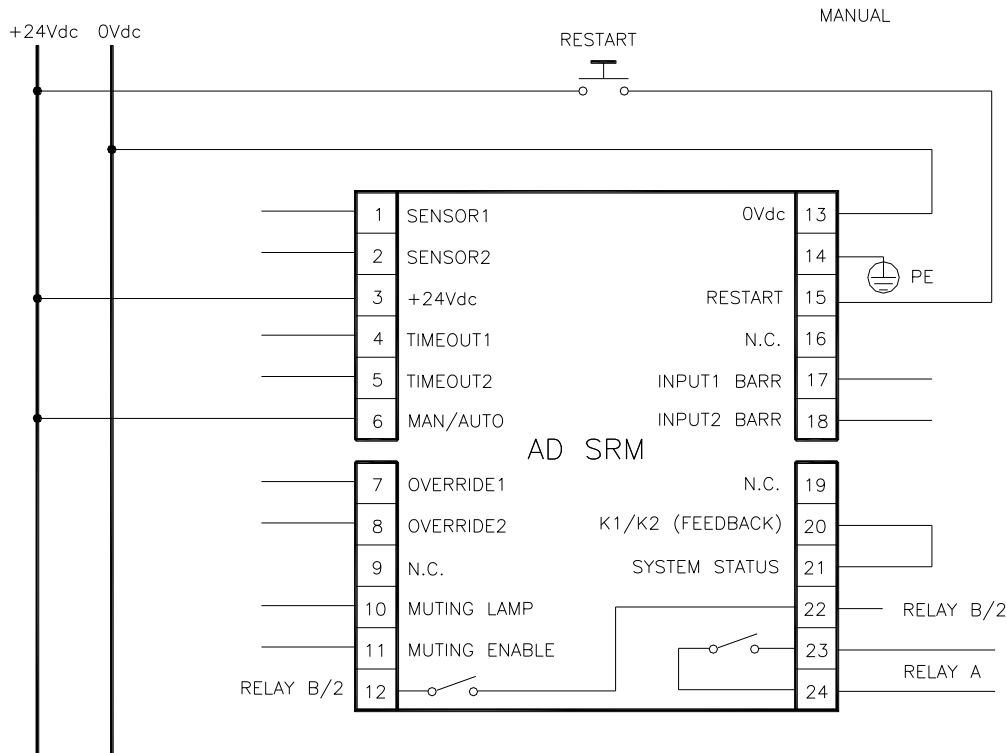

**NOTE:** refer to the "CONNECTON EXAMPLES" section to see the muting signals connection

**Figure 7**

### CONNECTION OF K1 K2 EXTERNAL CONTACTORS

Control of external contactors K1K2 can be activated in both operating modes. If this control is to be used, the set of normally closed contacts of the external contactors must be connected to terminal 20 of the safety module (Figure 8 and Figure 9).

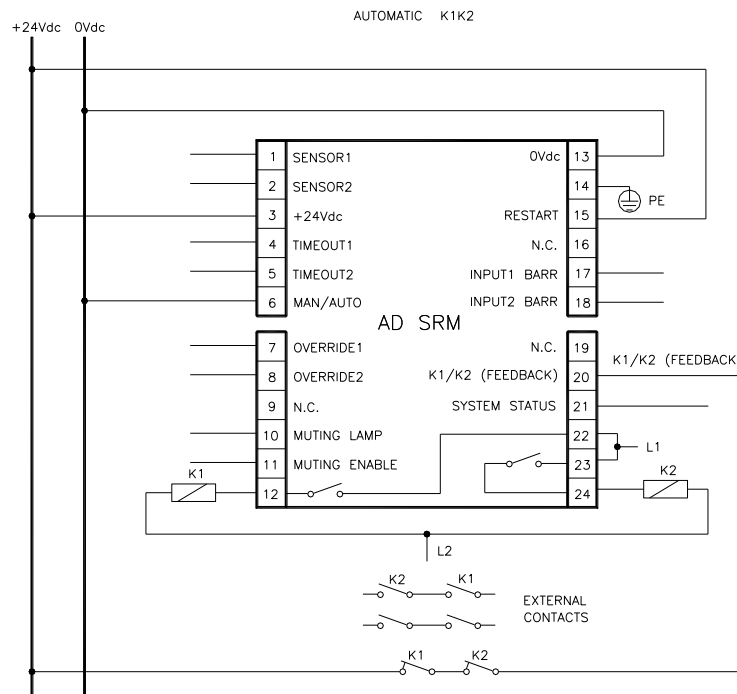

**Figure 8**  
**Automatic operation with K1K2 relays**

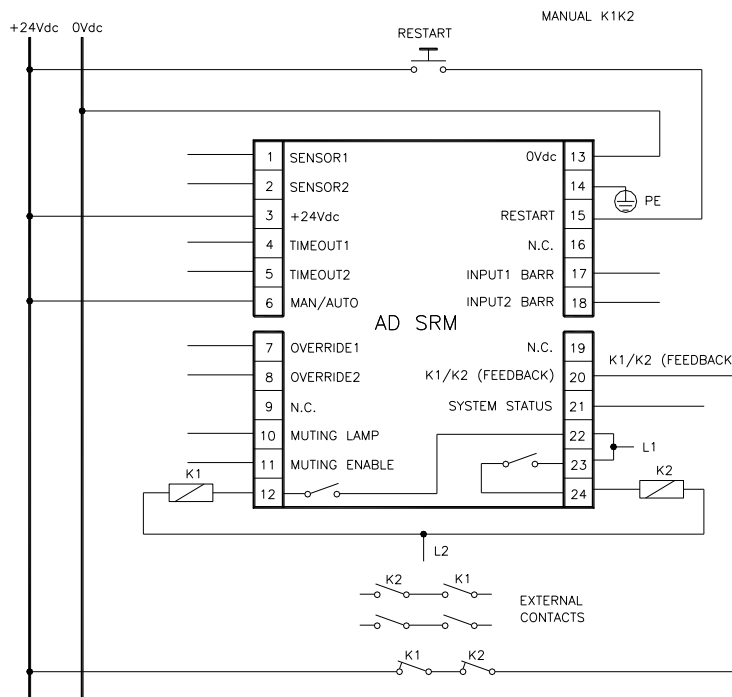

**Figure 9**  
**Manual operation with K1K2 relays**

**NOTE:** refer to the "CONNECTON EXAMPLES" section to see the muting signals connection

**CONNECTON EXAMPLES**

**CONNECTION OF AD SRM WITH AN ADMIRAL BARRIER (MANUAL MODE, WORKING RANGE=HI, K1K2 EXTERNAL CONTACTORS, TIMEOUT MUTING=30s)**

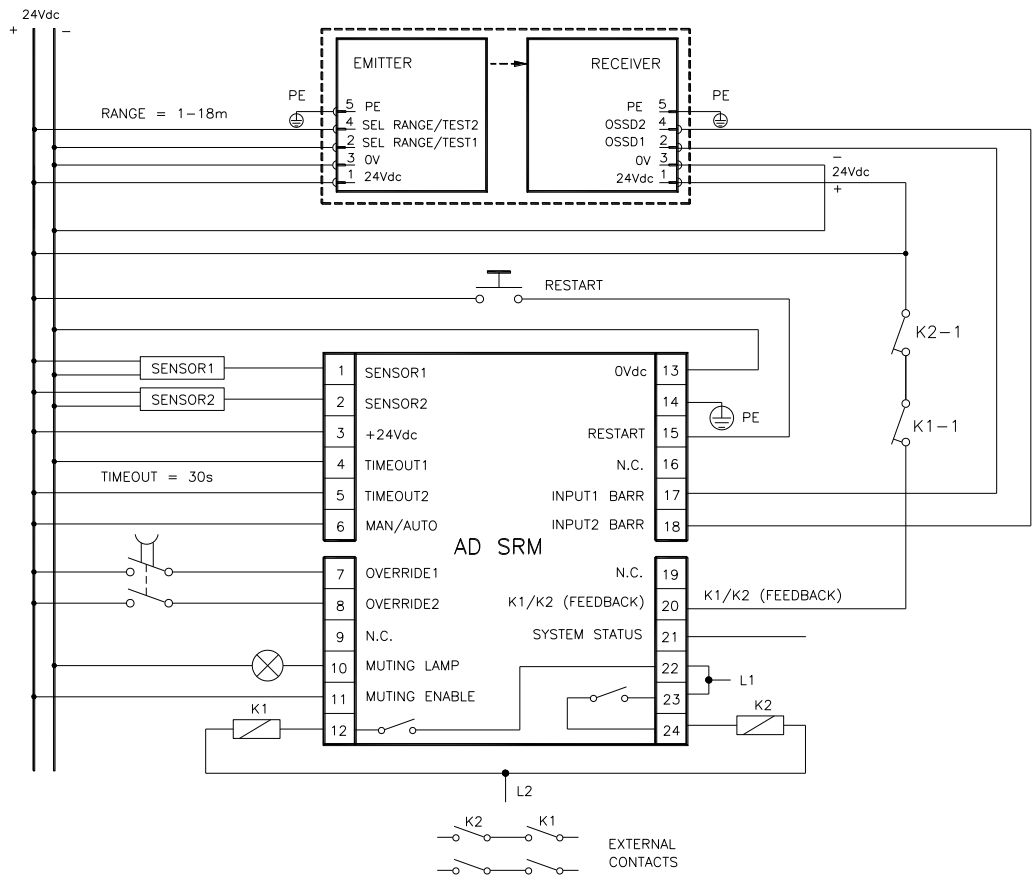

Figure 10

**MUTING FUNCTION**

**⚠** The Muting function is a temporary suspension of the safety light curtain’s protective function. Carefully check your risk analysis in order to assess whether the Muting function is compatible with your application and what additional measures have to be taken.

The Muting function generates a temporary, automatic interruption of the protective action of the barrier in order to permit normal transit of material through the guarded opening.

The Muting function is activated when the system detects the object that interrupts the opening protected. In other words, when the system recognizes the material and distinguishes between this and any operator (in a potentially dangerous situation), it is enabled to bypass the light curtain temporarily, allowing the material to pass through the opening (Figure 11).

**The Muting sensors** form the sensing system that decides whether the Muting function is to be activated (or not). Control of the dangerous opening can be de-activated only by a correct sequence of interruption of the beams of the Muting sensors.



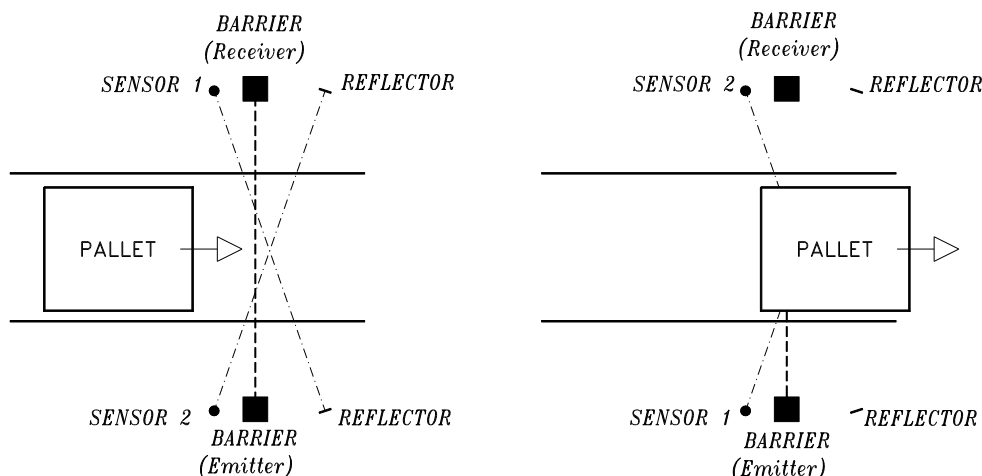

**Figure 11**  
Muting on palletizing system application example

### Muting sequence

The timing diagrams in Figure 12 and Figure 13 show the correct signal sequence. The muting function is initiated by the contemporary occurrence of two events :

- When the two beams of the muting sensors are activated within a time limit of 4 sec.
- When the muting enable signal (terminal 11) is high (+24Vdc)

The muting function is terminated by one of the following events:

- As soon as one of the muting sensors is no longer activated whichever occurs first.
- When the muting time-out limit is expired; in this case the OSSDs are brought to the off-state. The muting time-out limit can be selected at 30sec or  $\infty$ .

- ➔ The muting enable command will only enable the muting function and should be generated at the appropriate time by the machine control system (e.g. When the muting function is needed); it has no effect on the deactivation of the muting function. If not used, fix the terminal 11 at +24Vdc.
- ➔ **Remember that muting is a temporary automatic suspension of the safety function.** This means that a time limit is always mandatory. If a time out limit of 30 sec is a too short time for a particular machine cycle, the configuration without time monitoring ( $t = \infty$ ) can be selected. In this case alternative solutions or additional measures shall be implemented to **detected the condition of a muting function permanently active caused by accumulation of faults** or by the muting sensors activated all the time. For example for the application of guarding the openings of a conveyor system (palletizers) by monitoring appropriate signals generated by the transport system to determinate if and when a pallet is in the detection zone.

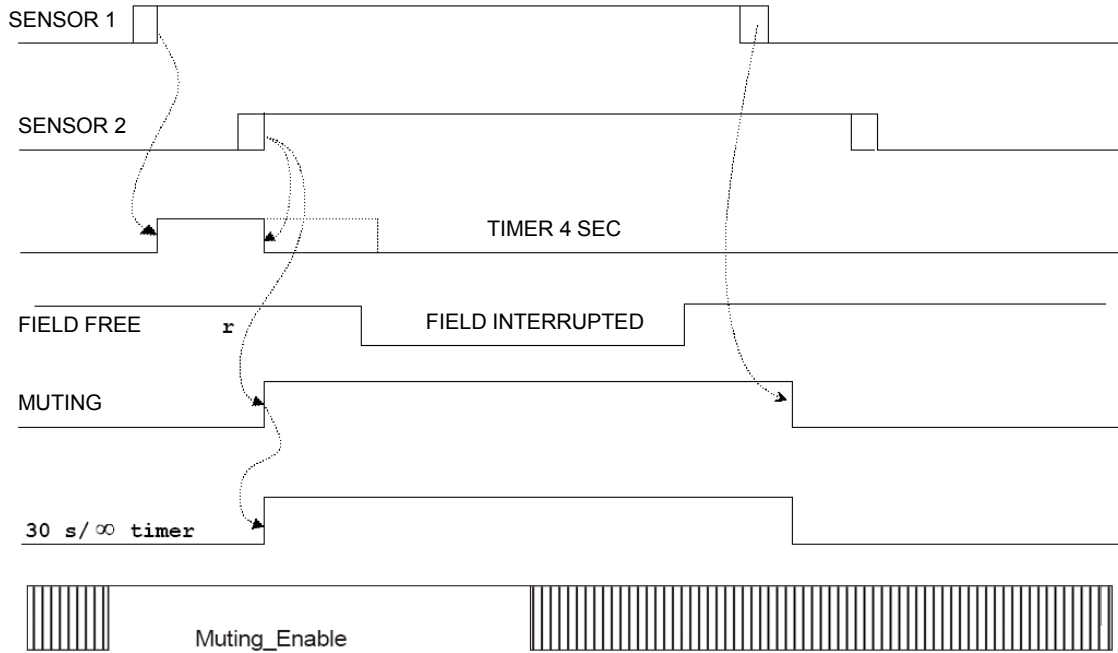

**Figure 12**  
**Muting cycle**

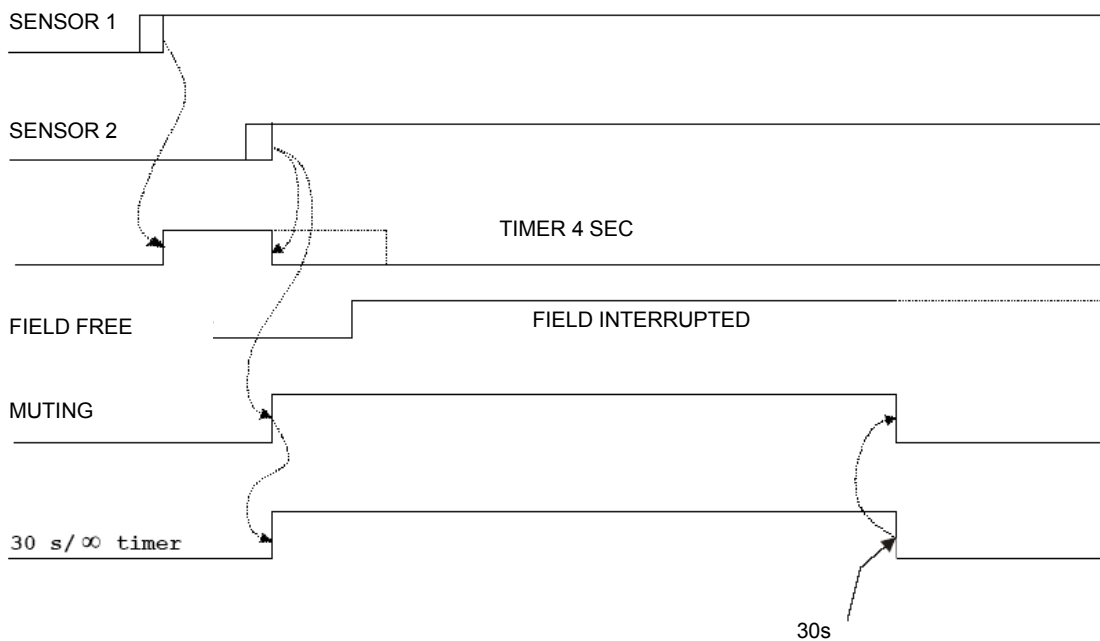

**Figure 13**  
**Muting cycle closed by a timeout**

**MUTING OVERRIDE FUNCTION**

The OVERRIDE function must be used when the machine stops due to incorrect Muting activation sequences with the material obstructing the guarded opening.

In this situation, the OSSD outputs are not active as the barrier and/or at least one Muting sensor is occupied. In this condition the OVERRIDE request led blinks (ref. "Status Indicators").

- ☠ This function activates the OSSD outputs making it possible to remove the material that is obstructing the protected field.
- ☠ Throughout the entire phase during which the OVERRIDE function is active, the OVERRIDE/MUTING light blinks. Check efficiency of this light periodically (during the Muting or Override phases).
- ☠ Warning!! The Override with pulse command automatically activates the outputs of the light curtain until both the light curtain and the muting sensors are free of obstacles again. During this period, the light curtain is unable to protect access to the guarded opening. Therefore, all operations must be carried out under the strict supervision of expert personnel.
- ☠ During the installation of the module be sure to avoid short circuits between the contacts 7 and 8.

The operator will use the Override mode previously selected.

1. Override with maintained action control.
2. Override with pulse control.

#### ***Override with maintained action control***

This function is activated driving terminals 7 and 8 of the control unit to +24VDC at the same time (**maximum delay = 400ms**) using for example a 2-way key selector with spring return;

PIN 7	PIN 8	CONDITION
0	0	Normal operation
24VDC	24VDC	OVERRIDE request

The maximum override duration is 15 minutes; it can be stopped for two different causes.

- ➔ **When the selector is released or if the 15 minutes has been elapsed, override ends**, de-activating the OSSD outputs, turning off the muting lamp and showing normal condition on the display. A new override condition can be started, releasing and rearming the selector.
- ➔ **Once the opening has been cleared and the sensors are free again**, override ends and GUARD condition (control unit in normal operation) is activated without necessity of further commands.

#### ***Override with pulse control***

This function is activated inverting (**maximum delay = 400ms**) the condition of pin 7 and 8 of the receiver using for example a push button (switch). During the override the 7 and 8 are not controlled.

PIN 7	PIN 8	CONDITION
0	24VDC	Normal operation
24VDC	0	OVERRIDE request

- ➔ The override condition can last a maximum of **15 minutes** (repeatable).

- ➔ The function can only be re-started by pressing the pushbutton again (**subject to the following conditions**):
  1. Maximum total OVERRIDE time (after  $n$  consecutive requests) = **60 min**
  2. Maximum number of consecutive requests for OVERRIDE = **30**.
- ➔ The override condition ends when the barrier and sensors are cleared (entrance clear) and the GUARD condition is re-enabled (barrier fully operational) without sending any further commands.
- ➔ The timer (point 1) and counter (point 2) are reset when one of the following conditions occurs:
  - A correct muting sequence.
  - A system reset (switched off and then turned on).

## STATUS INDICATORS

1 2 3	13 15
4 5 6	16 17 18
	IN
	FAIL
	GUARD BREAK
ADMIRAL	AD SRM
7 8 9	19 20 21
10 11 12	22 23 24

LED	COLOR	STATUS	DESCRIPTION
S1	Yellow	OFF	Muting sensor 1 free
		ON	Muting sensor 1 interrupted
S2	Yellow	OFF	Muting sensor 2 free
		ON	Muting sensor 2 interrupted
MUT	Yellow	OFF	Correct operation
		ON	Muting active
		Blinking	<ul style="list-style-type: none"> <li>• Override request</li> <li>• Muting fail (only with FAIL led ON) *</li> </ul>
IN	Green	OFF	Barrier interrupted
		ON	Barrier free
FAIL	Red	OFF	No Failure
		ON	Failure detected *
GUARD BREAK	Green Red Yellow	GREEN	Output relays closed
		RED	Output relays opened
		RED Blinking	The number of blinkings shows the kind of FAIL (only with FAIL RED) *
		YELLOW	Barrier free - Output relays opened (only in manual operative mode)

Table 8

\* REFER TO THE "FAULT DIAGNOSIS" SECTION TO HAVE A DETAILED EXPLANATION OF THE POSSIBLE FAULT

## INSTALLATION AND ELECTRICAL CONNECTIONS

- Install the AD SRM safety module in an environment with a protection rating of at least IP54.
- If more modules AD SRM must be installed in the same board panel, in order to avoid overheating, maintain between them one minimal distance of 2cm.
- The AD SRM control unit must be supplied with a 24Vdc  $\pm 20$ .
- The external power supply must comply with the standard EN 60204-1.
- During the installation of the AD SRM control unit be sure to avoid short circuits between the contacts 17 and 18.

### **Characteristics of the output circuit.**

For the output circuit, the control unit uses two guided contact safety relays.

These relays are rated by the manufacturer for voltage and current values above those indicated in the technical data; however, to assure correct insulation and to avoid damage or premature aging, protect each output line with a 4A slow-blow fuse and check that load characteristics comply with the indications given in the table below.

Minimum switching voltage	18 Vdc
Minimum switching current	20 mA
Maximum switching voltage	250Vac
Maximum switching current	2A

### **Use of K1 and K2 auxiliary contact elements.**

For loads with higher voltage and current characteristics than those indicated in the table above, use of auxiliary external relays or contactors suitable for the load to be controlled is recommended.

- The K1 and K2 auxiliary contactors or relays must be of the guided contact safety type.
- Referring to the table below, pay particular attention to the configuration of the control contacts on terminal 20 and that of the contacts of use.

	Relay K1	Relay K2
<b>Control contacts</b>	K1-1 normally closed	K2-1 normally closed
<b>Use contacts</b>	K1-2 normally open	K2-2 normally open

- Control contacts K1-1 and K2-1 (terminal 20) must be able to switch a current of 20mA and a voltage of 24Vdc.
- To increase the electrical life of internal relays A and B, it is advisable to use anti-disturbance devices which must be connected across the coils of K1 and K2.

### **Warnings regarding the connection cables.**

- For light curtain/control unit connections of more than 50m, cables with a cross-section of at least 1mm<sup>2</sup> must be used.
- It is good practice to separate the power supply of the control unit from that of other electrical appliances (electrical motors, inverters, frequency variators) or other sources of disturbance.
- The path of the connection cables between the control unit and the sensors, the connection referring to the test command and feedback contacts connected to terminal 20 must be different from that of other power cables.

**SIGNALS DESCRIPTION**

TERMINAL NUMBER	SIGNAL NAME	TYPE OF SIGNAL	DESCRIPTION
1	SENSOR 1	Input	Muting Sensor n°1
2	SENSOR 2	Input	Muting Sensor n°2
3	24VDC	Input	Power supply 24Vdc
4	TIMEOUT 1	Input	Timeout selection n°1 *
5	TIMEOUT 2	Input	Timeout selection n°2 *
6	MAN/AUTO	Input	Manual/Automatic configuration
7	OVERRIDE 1	Input	Override selection n°1 **
8	OVERRIDE 2	Input	Override selection n°2 **
9	N.C.	-	-
10	MUTING LAMP	Output	Muting lamp output
11	MUTING ENABLE	Input	External muting enable input
12	Relay B NO1	Output	Safety relay B, contact 1 (N.O.)
13	0VDC	Input	Power supply 0Vdc
14	PE	-	Ground connection
15	RESTART	Input	Restart command Input
16	N.C.	-	-
17	INPUT1 BARR	Input	Barrier input 1
18	INPUT2 BARR	Input	Barrier input 2
19	N.C.	-	-
20	K1/K2 (Feedback)	Input	K1K2 external contactors feedback
21	SYSTEM STATUS	Output	Output safety relays status
22	Relay B NO2	Output	Safety relay B, contact 2 (N.O.)
23	Relay A NO1	Output	Safety relay A, contact 1 (N.O.)
24	Relay A NO2	Output	Safety relay A, contact 2 (N.O.)

Table 9

\* REFER TO THE Table 10 FOR THE SELECTION OF THE MUTING TIMEOUT  
**Read carefully the "Muting sequence" section to select the right timeout**

SELECTION OF THE MUTING TIMEOUT		
TERMINAL 4	TERMINAL 5	DURATA TIMEOUT
0 Vdc	+24 Vdc	30s
+24 Vdc	0 Vdc	Infinite
0 Vdc	0 Vdc	Conditions not allowed
+24 Vdc	+24 Vdc	

Table 10

\*\* REFER TO THE Table 11 FOR THE SELECTION OF THE OVERRIDE

SELECTION OF THE OVERRIDE		
TERMINAL 7	TERMINAL 8	TIPO DI OVERRIDE
0 Vdc	0 Vdc	Spring return key
0 Vdc	+24 Vdc	Push button
+24 Vdc	0 Vdc	Conditions not allowed
+24 Vdc	+24 Vdc	

Table 11

### The RESTART command

- The RESTART command must be sent to the control unit connecting terminal 15 to the +24Vdc.
- The contact used for the RESTART command must be able to switch a voltage of 24Vdc and a current of 20mA (guaranteeing a closing time > 100ms). This data is particularly important in the case of automatic management of sending of the RESTART command, for example using a PLC.
- The SYSTEM RESET TIME is obtained adding the reset time of any external contactors K1K2 to the reset time of the AD SRM control unit (100ms).
- In the case of manual activation, a normally open external button can be used, temporary closing of which generates the RESTART command.

- ⚠ The Restart command must be installed outside the danger area in a position where the danger area and the entire work area concerned are clearly visible.
- ⚠ It must not be possible to reach the RESTART control from inside the danger area.

### K1K2 FEEDBACK input

Using the K1 and K2 auxiliary safety contactors with guided contact safety type, it is necessary to connect the +24Vdc to the **K1K2 FEEDBACK** through the series of the K1-1 e K2-1 N.O. control contacts. The control of the correct switching of K1 and K2 is performed with a delay of 300ms after the real command.

When the K1-1 e K2-1 N.O. control contacts are not used (or no control is provided) it is mandatory to connect the terminal 20 (**K1K2 FEEDBACK**) to the terminal 21 (**SYSTEM STATUS**).

### SYSTEM STATUS output

The SYSTEM STATUS output reports exactly the output safety relays status :

- When the output relays are opened, the SYSTEM STATUS reports 0VDC.
- When the output relays are closed, the SYSTEM STATUS reports +24VDC.

## DIMENSIONS

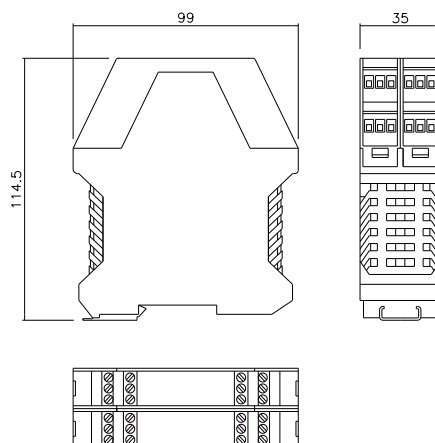

Figure 14

**TECHNICAL DATA AD SRM**

Safety category		4
Power supply	Vdc	24 ± 20%
Power requirement	W	5 max
Output	Relay	2 N.O. contacts (2A; 250V)
Response time	ms	20 max
Operating modes		Manual or Automatic, selectable from terminal block
External relay control		2 N.C. contacts (20mA; 24Vdc)
Number of connectable barriers		1 (with 2 PNP safety static outputs)
Muting sensors input		2 sens. (24VDC; PNP; dark-on)
Muting enable input		24VDC, PNP
System Status Output		100mA; 24Vdc
Muting lamp output		24Vdc / 0,5 ÷ 5 W
Connections	min	Terminal block with protection against reversal of polarity
Status indicators		Power On - Barrier Status - Fail - Muting active - Override active
Number of connectable photocells	Led	2 sens. (24VDC; PNP; dark-on)
Max. length of connections	m	100
Operating temperature	°C	0 ÷ 55
Enclosure protection rating		IP 20
Terminal block protection rating		IP 2X
Fastening		Fast attachment to rail according to EN 50022-35
Dimensions (h x w x d)	mm	99 x 35 x 114,5
Weight	g	150
B10d		800.000
Device lifetime		20 years
Safety level	Type 4	IEC 61496-1:2004 IEC 61496-2:2006
	SILCL 3	IEC 62061:2005
	Cat.4	ISO 13849-1 : 2006

Load	Number of Commutations	PFHd *	DCavg #	MTTFd #	PL #	CCF #
2A@230Vac	1 every 30s	2,80E-08	98,89%	25,97	d	80%
	1 every min	1,71E-08	98,78%	49,92	e	80%
	1 every hour	6,58E-09	96,68%	100,00	e	80%
	1 every day	6,42E-09	96,25%	100,00	e	80%
0,5A@24Vdc	1 every 30s	5,03E-08	98,94%	13,25	d	80%
	1 every min	2,80E-08	98,89%	25,97	d	80%
	1 every hour	6,76E-09	97,01%	100,00	e	80%
	1 every day	6,43E-09	96,28%	100,00	e	80%

**Table 12**

\* IEC 62061

# ISO 13849-1



## STATUS INDICATORS / FAULT DIAGNOSIS

### Status indicators (BASE MODULE)

LED			MEANING
IN (GREEN)	FAIL (RED)	GUARD/BREAK (RED/YELLOW/GREEN)	
ON	ON	Red	Power up test
OFF	OFF	Red	Photocell interrupted Output relays opened
ON	OFF	Yellow	Photocell free Output relays opened
ON	OFF	Green	Photocell free Output relays closed

Table 13

### Status indicators (MUTING MODULE)

LED			MEANING
SENSOR1 (YELLOW)	SENSOR2 (YELLOW)	MUTING (YELLOW)	
ON	ON	ON	Power up test
OFF	OFF	OFF	Both the sensors are free
ON	OFF	OFF	Sensor 1 interrupted
OFF	ON	OFF	Sensor 2 interrupted
ON	ON	ON	Muting active
Shows the sensor_1 status	Shows the sensor_2 status	Blinking	Override request

Table 14

### Fault diagnosis











LED		MEANING	
IN GREEN	FAIL RED		
OFF	ON	 (2 pulses)	Internal fault
OFF	ON	 (3 pulses)	Internal relays fault
OFF	ON	 (4 pulses)	K1K2 external relays fault
OFF	ON	 (5 pulses)	User configuration failure
OFF	ON	 (6 pulses)	User configuration changed without system restart: Switch off and restart the module to solve the problem. At the switch on verify the new user configuration.
OFF	ON	 (7 pulses)	Possible overload or SYSTEM STATUS connection error

Table 15

**Status indicators (MUTING MODULE)**

**NOTE:** The following status signals are present with the base module permanently light on.

		LED		MEANING
SENSOR1 YELLOW	SENSOR2 YELLOW	MUTING YELLOW		
OFF	OFF	 (2 pulses)		Bad connection of the muting lamp, lamp not present or in overload
OFF	OFF	 (3 pulses)		Muting timeout wrong configuration
OFF	OFF	 (4 pulses)		Wrong override configuration at the power up
Shows the sensor_1 status	Shows the sensor_2 status	 (5 pulses)		Instable Muting Sensor
Blinking	Blinking	Blinking		Override with pulse command expired

 If it is not possible to clearly identify the malfunction and to remedy it, stop the machine and contact the ReeR's Assistance Service.

## GUARANTEE

ReeR warrants that each AD SR - AD SRM unit in new ex-factory condition, in conditions of normal use, is free of defects in the materials and of manufacturing defects for a period of 12 (twelve) months.

In this period, ReeR undertakes to eliminate any faults in the product through repair or replacement of the faulty parts, completely free of charge as regards material and labor. However, ReeR reserves the right to replace the entire faulty appliance with another equivalent appliance or with the same characteristics instead of repairing this.

Validity of this warranty is regulated by the following conditions:

- The user must inform ReeR of the fault within twelve months from the date of delivery of the product.
- The appliance and its components must be in the conditions in which they were delivered by ReeR.
- The serial numbers must be clearly legible.
- The fault or defect has not been caused directly or indirectly by:
  - Improper use;
  - Non-compliance with instructions for use;
  - Carelessness, inexperience, incorrect maintenance;
  - Repairs, modifications, adaptations not carried out by ReeR personnel, tampering, etc.;
  - Accidents or impacts (also due to transportation or causes of force majeure);
  - Other causes not to be ascribed to ReeR.

Repairs will be carried out at the ReeR laboratories to which the material must be delivered or dispatched: transport risks and the risks of any damage or loss of the material during shipment are the responsibility of the user.

All products and components replaced become the property of ReeR.

ReeR does not recognize any other warranties or rights except for those specifically described above; therefore, no claims for damages may be submitted for expenses, interruption of business or other factors or circumstances in any way related to failure of the product or of one of its parts.

*Precise, complete compliance with all the rules, instructions and prohibitions indicated in this handbook is an essential requirement for correct functioning of the safety interface.  
ReeR s.p.a. therefore declines any responsibility for all and anything resulting from failure to comply, even partially, with such indications..*

*Characteristics subject to change without notice. • Total or partial reproduction is forbidden without the prior authorization of ReeR.*